

Jupiter 500 - 850 med fast glas 2 sider

(Alle mål er i mm)

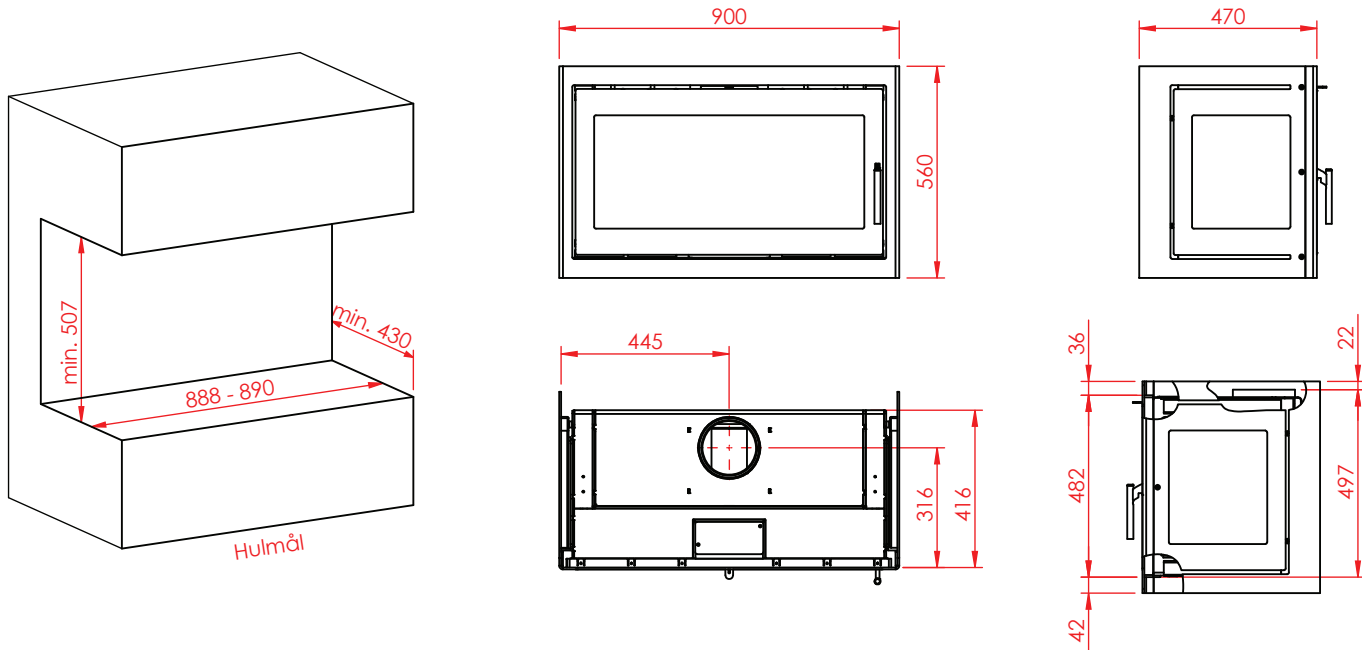

Jupiter 500 - 850 med fast glas 2 sider

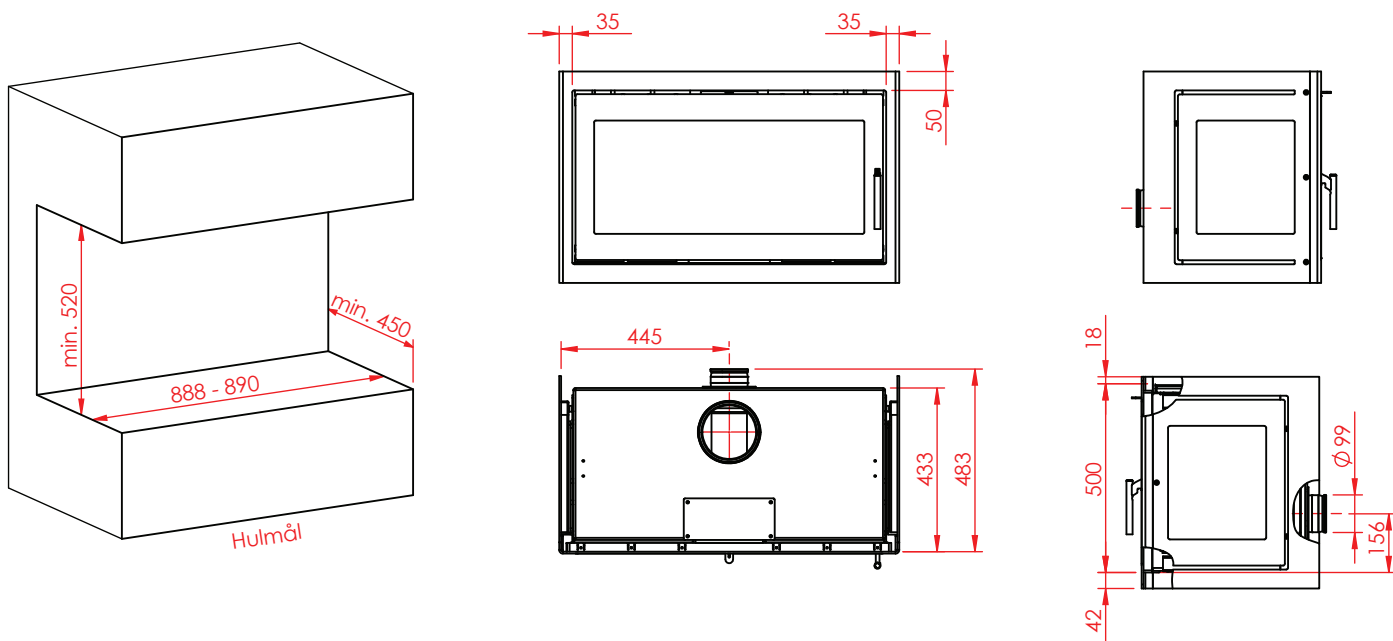

Jupiter 500 - 850 med fast glas 2 sider, friskluft bag

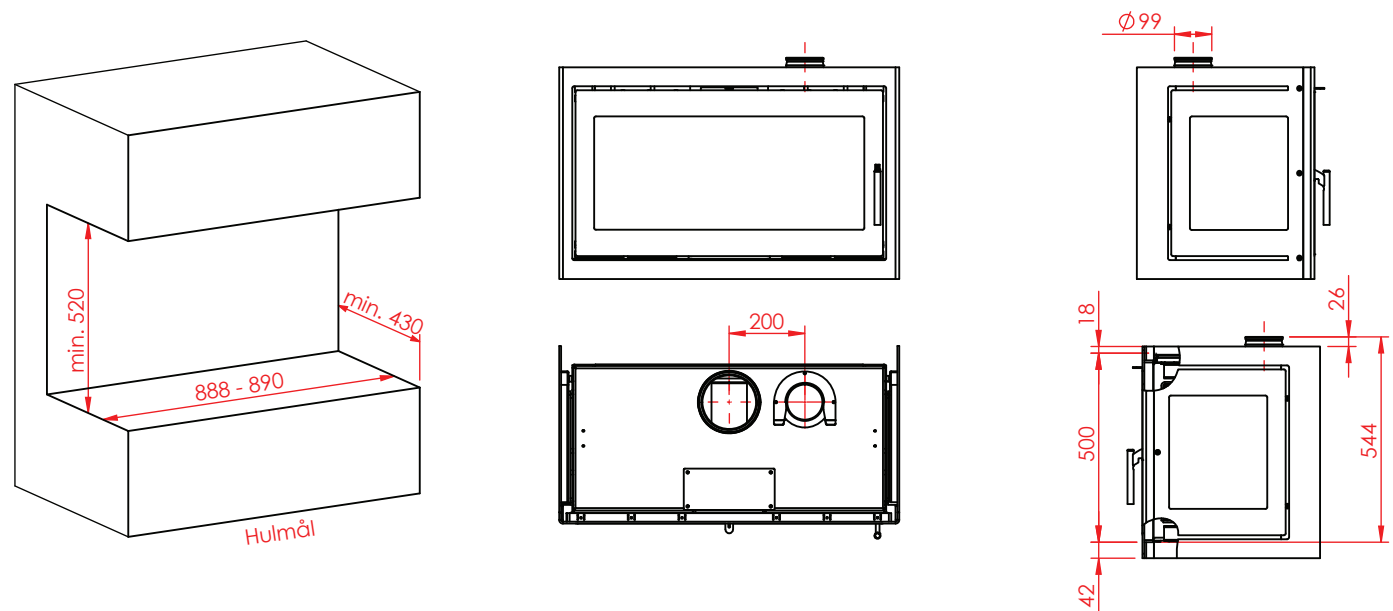

Jupiter 500 - 850 med fast glas 2 sider, friskluft top

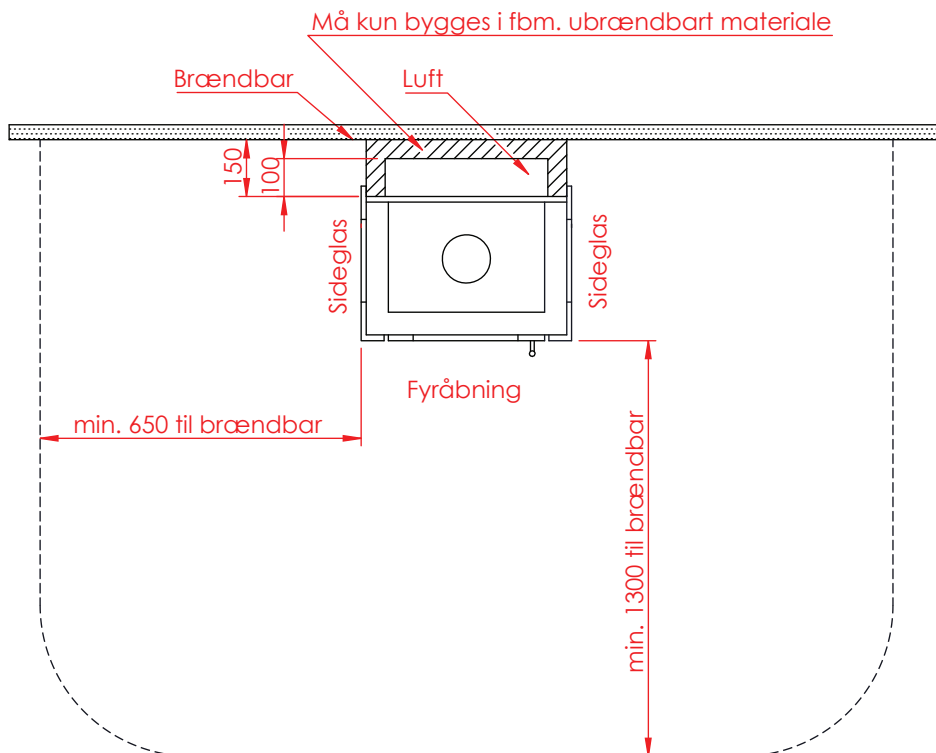

Afstand til brændbar

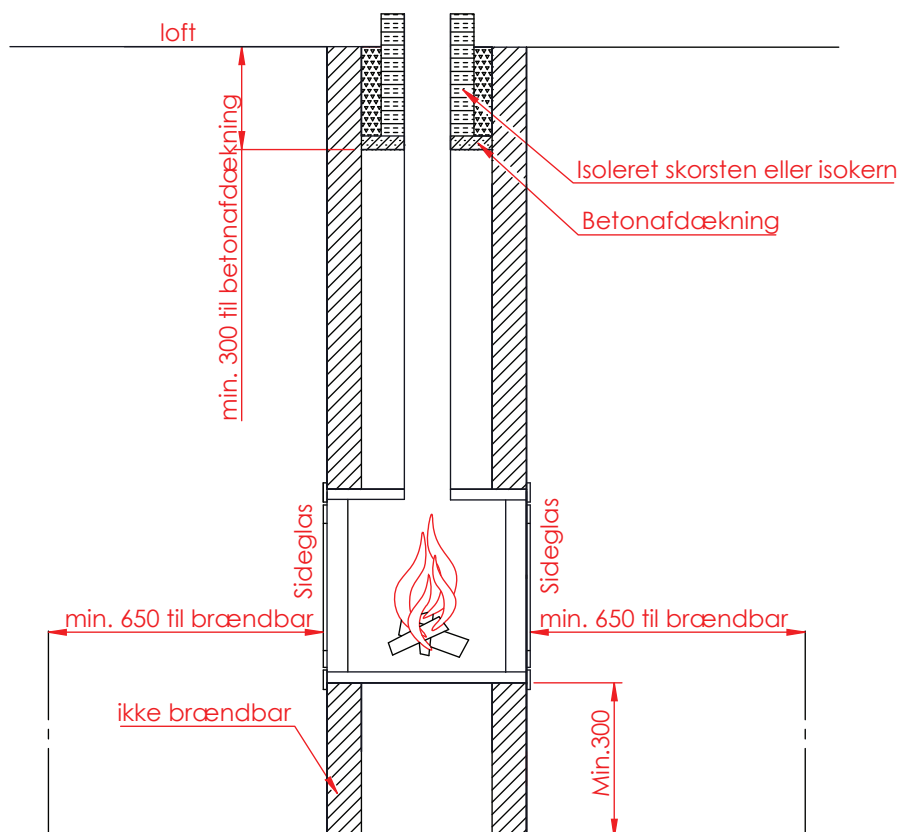

Afstand til brændbar