

Jupiter 550 - 850 med fast glas 2 sider

(Alle mål er i mm)

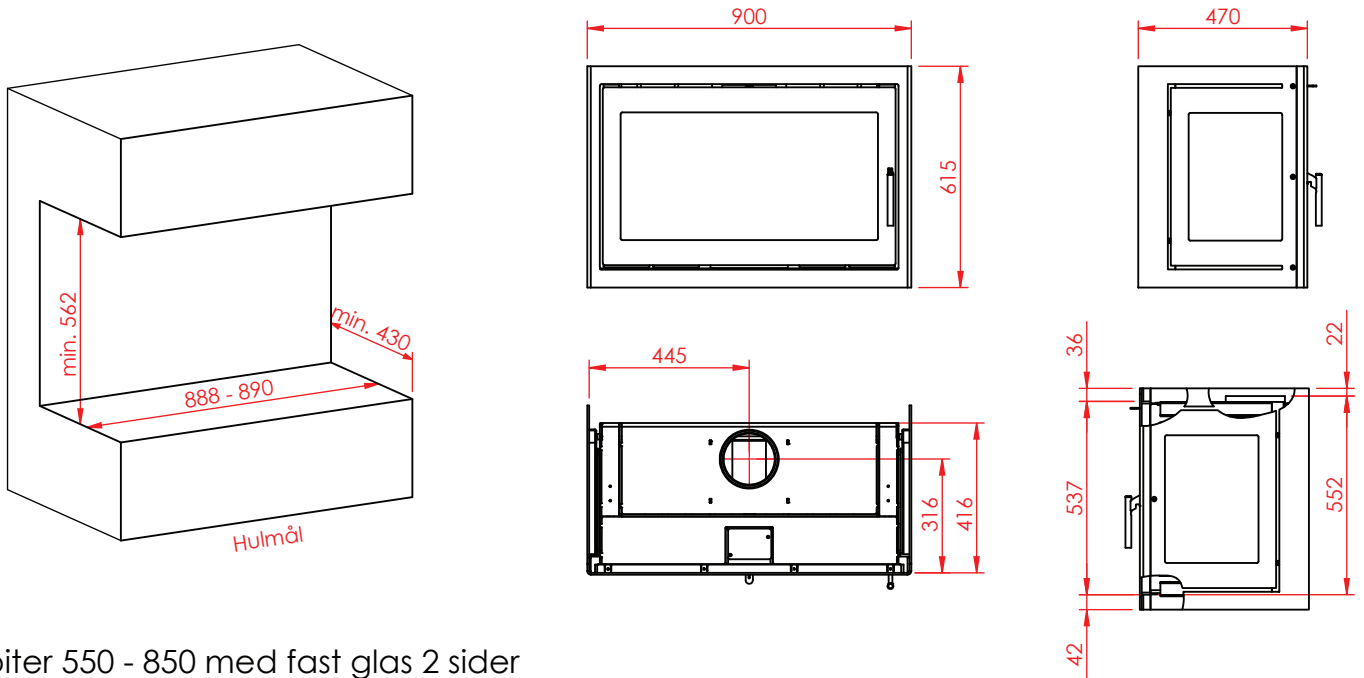

Jupiter 550 - 850 med fast glas 2 sider

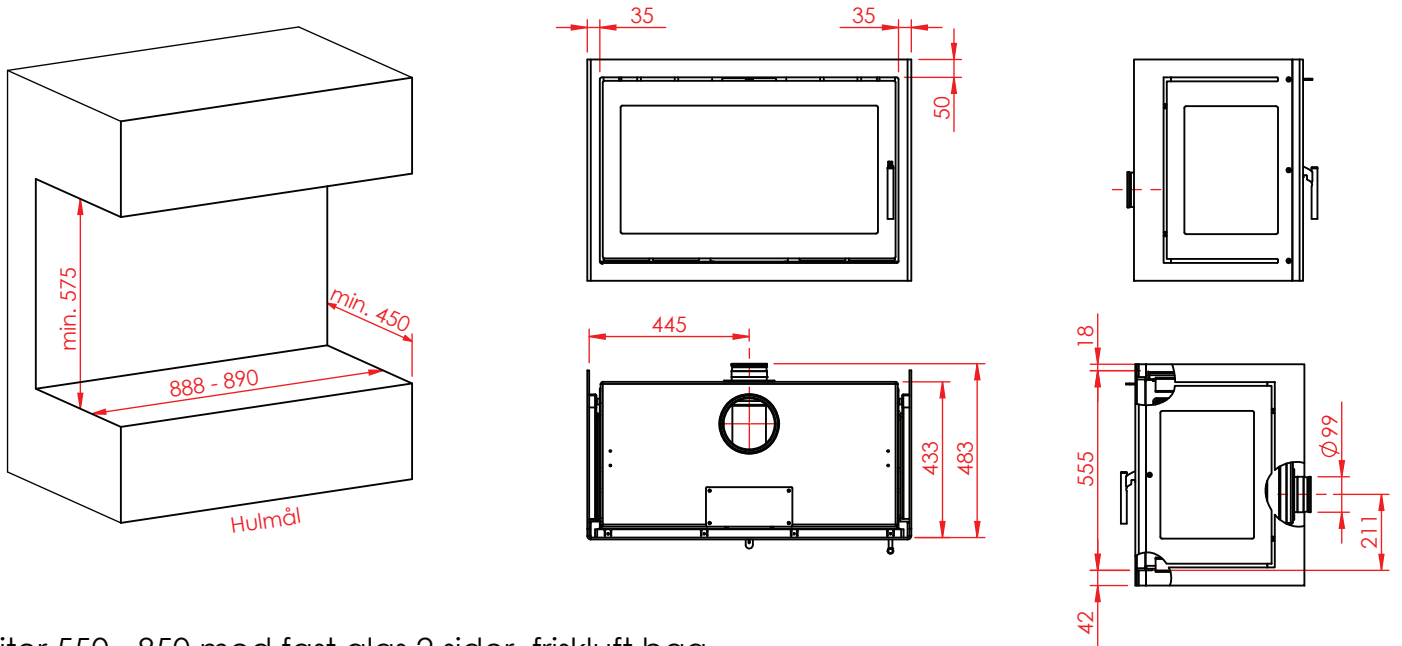

Jupiter 550 - 850 med fast glas 2 sider, friskluft bag

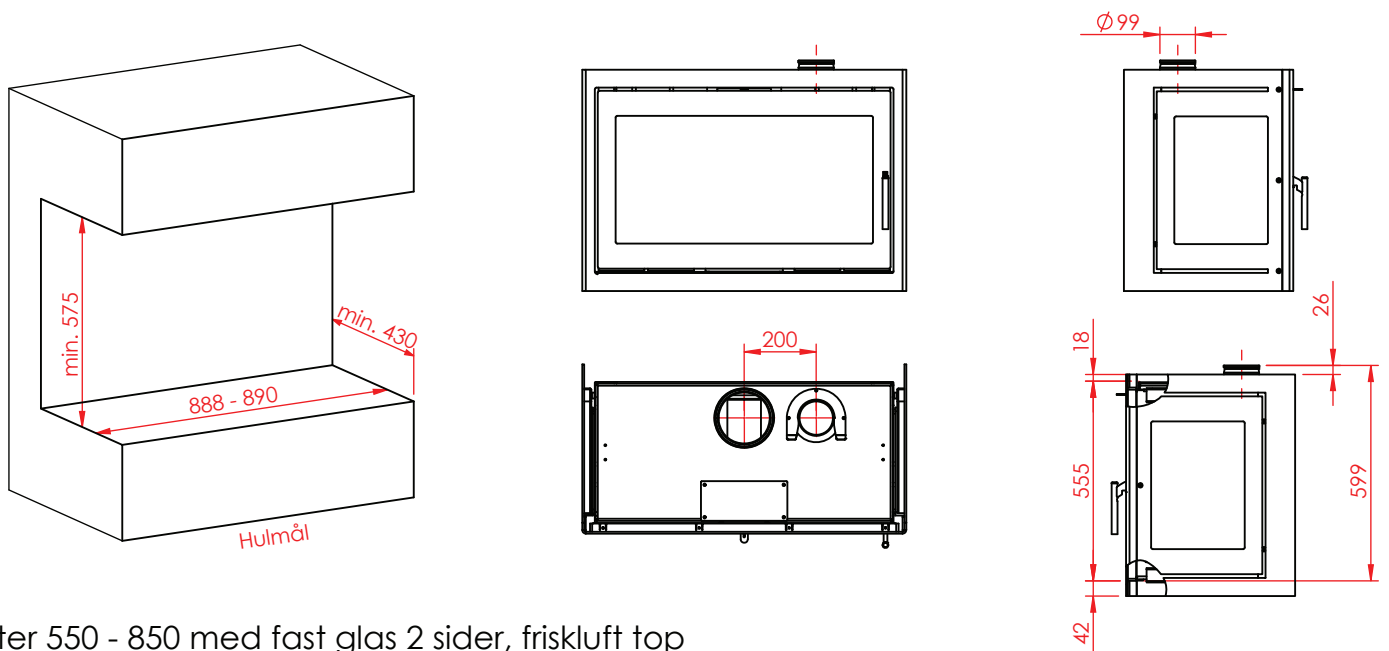

Jupiter 550 - 850 med fast glas 2 sider, friskluft top

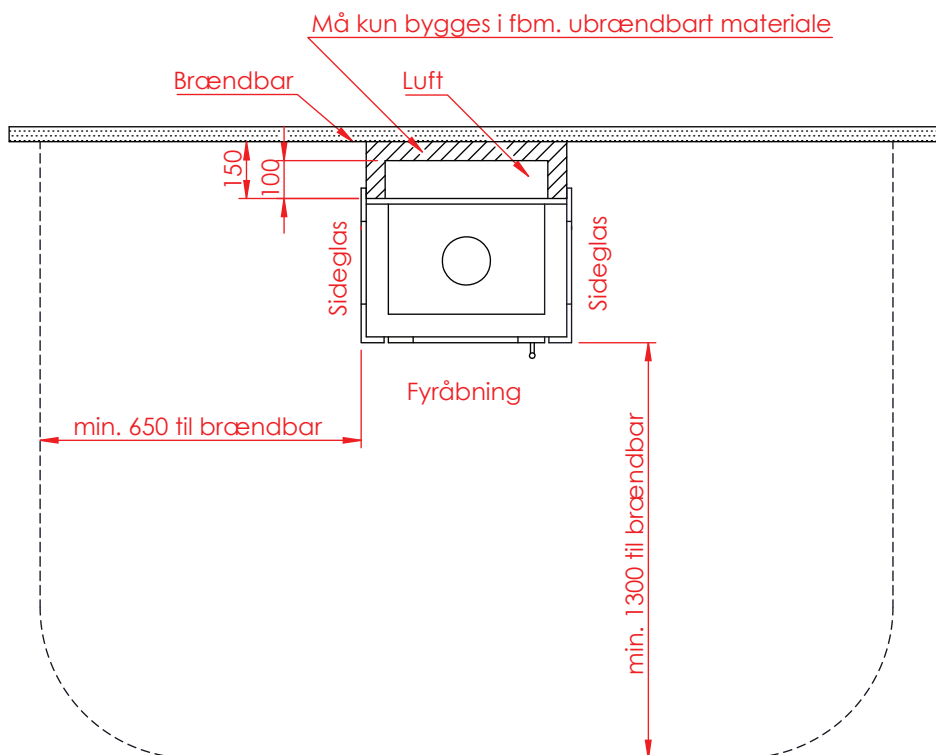

Afstand til brændbar

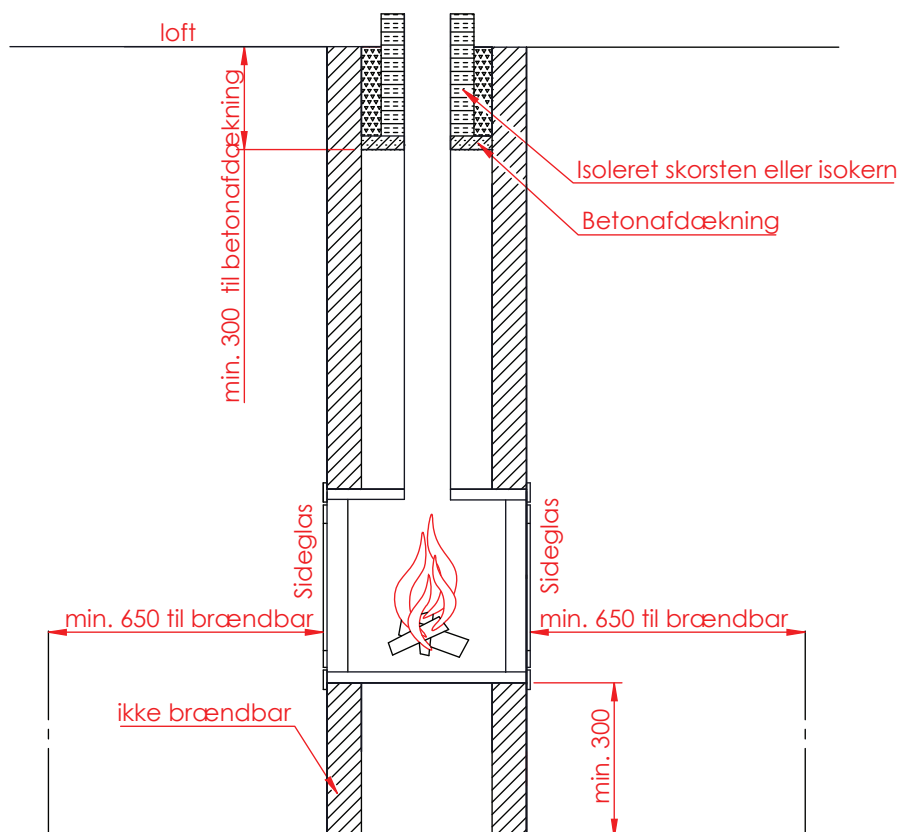

Afstand til brændbar